

Article number: 0101073  
 Description: Retaining ring A 56 DIN 471  
 Spring steel  
 Note: Fitted with ZGA pilers

## Measures

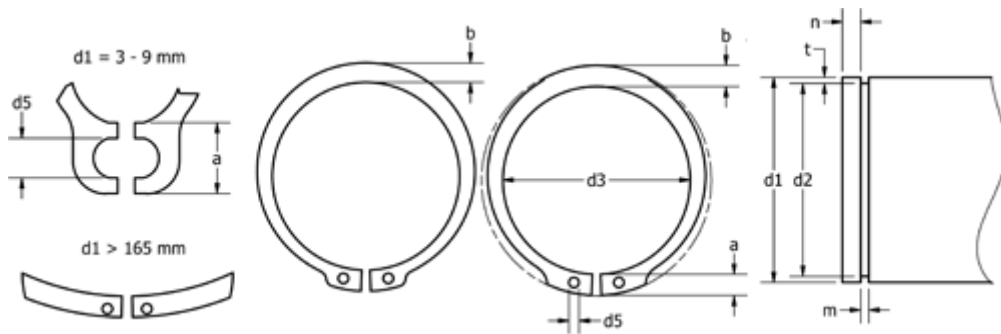

a max	= 7.3	FN kN	= 42.8	s	= 2.00
AN mm <sup>2</sup>	= 257.0	FRg kN	= 11.30	t	= 1.50
b	= 5.5	FR kN	= 70.80	tol	= -0.30
d1	= 56	g	= 2.5	tol	= -0.07
d2	= 53.0	K kN-mm	= 129.00	tol	= +0,46-1,10
d3	= 51.8	m min	= 2.15	Tong	= ZGA-3
d5 min	= 2.5	n abl x 1000	= 9.0	Weight kg/1000	= 11.800
Description	= A56	Nominal drive	= 4.5		